

Instruction Manual

HI2210 HI2211

Microprocessor-based pH/mV/°C Bench Meters

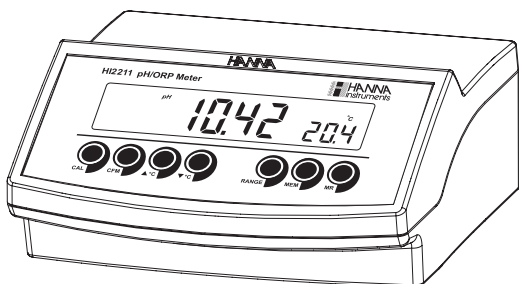

www.hannainst.com

Dear Customer,

Thank you for choosing a Hanna Instruments Office product.

Please read this instruction manual carefully before using these instruments. This manual will provide you with the necessary information for correct use of these instruments, as well as a precise idea of their versatility.

If you need additional technical information, do not hesitate to e-mail us at tech@hannainst.com or view our worldwide contact list at www.hannainst.com.

All rights are reserved. Reproduction in whole or in part is prohibited without the written consent of the copyright owner.

TABLE OF CONTENTS

PRELIMINARY EXAMINATION	4
GENERAL DESCRIPTION	4
FUNCTIONAL DESCRIPTION.....	5
SPECIFICATIONS	6
OPERATIONAL GUIDE	7
pH CALIBRATION	10
TEMPERATURE CALIBRATION (for technical personnel only)	13
pH BUFFER TEMPERATURE DEPENDENCE	15
ELECTRODE CONDITIONING AND MAINTENANCE.....	16
TROUBLESHOOTING GUIDE	19
TEMPERATURE CORRELATION FOR pH SENSITIVE GLASS	20
ACCESSORIES.....	21

PRELIMINARY EXAMINATION

Remove the instrument from the packing material and examine it carefully to make sure that no damage has occurred during shipping. If there is any damage, please contact your local Hanna Instruments Office. Each instrument is supplied with:

- **HI1131B** Glass-body Combination pH Electrode
- **HI7662** Temperature Probe
- **HI76404N** Electrode Holder
- **pH4.01 & 7.01** Buffer Solutions, 20 mL each
- **HI7082** Electrolyte Solution
- **HI700661** Cleaning Solution
- 12 VDC Power Adapter
- Instruction Manual
- Quality Certificate

Note: Save all packing material until you are sure that the instrument functions correctly. All defective items must be returned in the original packing with the supplied accessories.

GENERAL DESCRIPTION

The Hanna Instruments **HI2210** and **HI2211** are microprocessor based pH and temperature bench meters.

HI2211 can also be used for ion concentration (ISE) and Oxidation Reduction Potential (ORP) in the mV range.

pH measurements are compensated for temperature effect manually or automatically with the **HI7662** temperature probe.

The instrument is equipped with a large easy-to-read LCD which shows the pH (or mV) and temperature simultaneously, together with graphic symbols.

A stability indicator makes the calibration procedure error free.

FUNCTIONAL DESCRIPTION

Front Panel

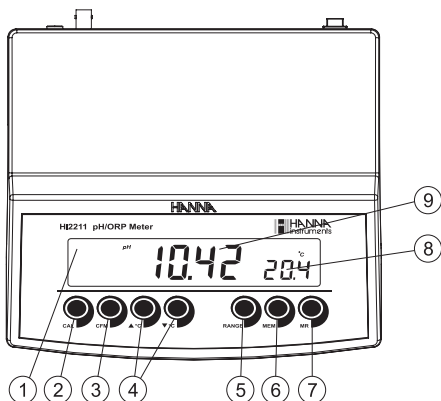

Rear Panel

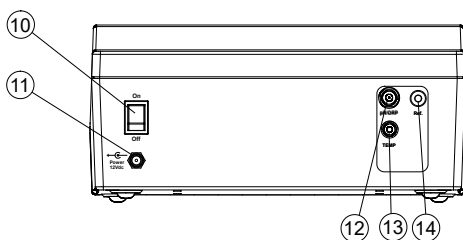

- 1) Liquid Crystal Display (LCD).
- 2) **CAL** key, to enter and exit calibration mode.
- 3) **CFM** key, to confirm different values.
- 4) ▲ °C and ▼ °C keys, to manually increase/decrease temperature or select pH buffer.
- 5) **RANGE** key, to select measurement range (HI2211 only).
- 6) **MEM** key, to store a value into memory.
- 7) **MR** key, memory recall.
- 8) Secondary LCD.
- 9) Primary LCD.
- 10) **ON/OFF** switch.
- 11) Power adapter socket.
- 12) BNC electrode connector.
- 13) Temperature probe socket.
- 14) Electrode reference socket.

SPECIFICATIONS

Range	-2.00 to 16.00 pH
	± 399.9 mV (HI2211 only) ± 2000 mV (HI2211 only)
	-20.0 to 120.0 °C
Resolution	0.01 pH
	0.1 mV (HI2211 only) 1 mV (HI2211 only)
	0.1 °C
Accuracy @20 °C / 68 °F	±0.01 pH
	±0.2 mV (HI2211 only) ±1 mV (HI2211 only)
	±0.4 °C (excluding probe error)
pH Calibration	Automatic, 1 or 2 point with 5 memorized buffer values (pH4.01, 6.86, 7.01, 9.18, 10.01)
Temperature compensation	Automatic (with HI7662 probe) or Manual from: -20.0 to 120.0 °C
pH Electrode	HI1131B (included)
Temperature probe	HI7662 (included)
Input impedance	10 ¹² Ohms
Power supply	12 VDC adapter (included)
Environment	0 to 50 °C (32 to 122 °F) max. 95% RH non-condensing
Dimensions	235 x 222 x 109 mm (9.2 x 8.7 x 4.3")
Weight	1.3 Kg (2.9 lbs)
Warranty	2 years

OPERATIONAL GUIDE

POWER CONNECTION

Plug the 12 VDC adapter into the power supply socket.

Notes: These instruments use non volatile memory to retain the pH, mV, temperature calibrations and all other settings, even when unplugged. Make sure a fuse protects the main line.

ELECTRODE AND PROBE CONNECTIONS

For pH or ORP combination electrode connect to the BNC connector on the back of the instrument.

For electrodes with a separate reference connect the electrode's BNC to the BNC connector and the reference electrode plug to the reference socket.

For temperature measurements and automatic temperature compensation connect the temperature probe to the appropriate socket.

INSTRUMENT START-UP

- Turn the instrument on by pressing the **ON/OFF** switch located on the rear panel.
- All LCD segments are displayed while the instrument performs a self test.



pH MEASUREMENTS

Make sure the electrode and the instrument have been calibrated together before taking pH measurements.

- Submerge the electrode and the temperature probe approximately 3 cm (1 1/4") into the sample to be tested and stir gently. Allow time for the electrode to stabilize.
- The pH is displayed on the primary LCD and the temperature on the secondary LCD.
- If the pH reading is out of range, the closest full scale value will be displayed blinking on the LCD.

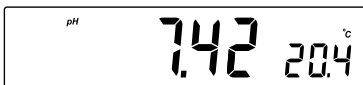
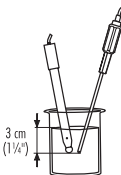

If measurements are taken successively in different samples, it is recommended to rinse the electrode thoroughly with deionized water or tap water and then with some of the next sample in order to prevent cross-contamination.

The pH reading is affected by temperature. In order to measure the pH accurately, the temperature effect must be compensated for. To use the **Automatic Temperature Compensation** feature, connect and submerge the **HI7662** temperature probe into the sample as close as possible to the electrode and wait for a few seconds.

If the temperature of the sample is known, manual temperature compensation can be used by disconnecting the temperature probe.

The display will show the last recorded temperature reading with the "°C" tag blinking.

The temperature can now be adjusted with the **ARROW** keys (from -20.0 °C to 120.0 °C).

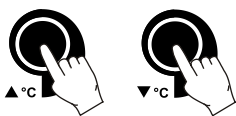

ORP MEASUREMENTS (HI2211 only)

An optional ORP electrode must be used to perform ORP measurements (see Accessories).

Oxidation-reduction potential (REDOX) measurements provide the quantification of the oxidizing or reducing power of the tested sample. The surface of the ORP electrode must be clean and smooth in order to obtain an accurate measurement.

- Press **RANGE** to enter mV range.
- Submerge the tip of the ORP electrode 3 cm (1¼") into the sample to be tested and allow a few seconds for the reading to stabilize.
- The instrument displays the mV reading on the primary LCD and the temperature on the secondary LCD.

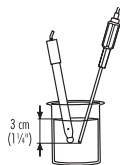

- If the reading is out of range, the closest full scale value will be displayed blinking on the LCD.

TEMPERATURE MEASUREMENTS

Connect the **HI7662** temperature probe to the TEMP socket and turn the instrument on.

Submerge the temperature probe into the sample and allow the reading on the secondary LCD to stabilize.



MEMORY FUNCTION

Press and hold down **MEM** key to store the last reading in the meter's memory. The "MEM" tag will be displayed.



Press **MR** (memory recall) key to display the memorized reading. The "MEM" tag will be displayed.

pH CALIBRATION

Calibrate the instrument often, especially if high accuracy is required.

The instrument should be recalibrated:

- Whenever the pH electrode is replaced.
- At least once a week.
- After testing aggressive chemicals.

PREPARATION

Pour small quantities of the buffer solutions into clean beakers. If possible use plastic or glass beakers to minimize any EMC interferences. For accurate calibration and to minimize cross-contamination, use two beakers for each buffer solution: one for rinsing the electrode and one for calibration.

If you are measuring in the acidic range, use pH7.01 or pH6.86 as first buffer and pH4.01 as second buffer. If you are measuring in the alkaline range, use pH7.01 or pH6.86 as first buffer and pH10.01 or pH9.18 as second buffer.

PROCEDURE

A two-point calibration is recommended however a one-point calibration will be permitted. Calibration can be performed using the five memorized buffers:

- pH4.01, 6.86, 7.01, 9.18 and 10.01.

TWO-POINT CALIBRATION

- Submerge the pH electrode and the temperature probe approximately 3 cm (1¼") into a buffer solution and stir gently. The temperature probe should be close to the pH electrode.
- Press **CAL**. The "CAL" and "BUF¹" messages will appear and "7.01" buffer will be displayed on the secondary LCD.

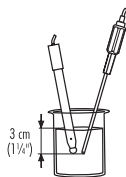

- If necessary, press the **ARROW** keys to select a different buffer value.



- The "Σ" symbol will blink on the LCD until the reading is stable.

- When the reading is stable and close to the selected buffer, "READY" message will appear and "CFM" message will blink.
- Press **CFM** to confirm calibration.
- The calibrated value is then displayed on the primary LCD and the secondary LCD will display the second expected buffer value.



- After the first calibration point is confirmed, submerge the pH electrode and the temperature probe approximately 3 cm (1¼") into the second buffer solution and stir gently. The temperature probe should be close to the pH electrode.

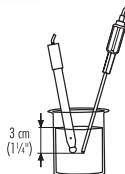

- If necessary, press the **ARROW** keys to select a different buffer value.





Note: The instruments will automatically skip the buffer used for the first point. It also skips 6.86 if 7.01 buffer was used and vice versa. Likewise, it will skip 9.18 if 10.01 buffer was used and vice versa.

- The "Σ" symbol will blink on the LCD until the reading is stable.
- When the reading is stable, "READY" message will appear and "CFM" message will blink.



- Press **CFM** to confirm calibration. The instrument will return to measurement mode.

Notes: • To clear previous calibration data enter calibration mode, press and hold down **CFM**, then press **CAL**. The display will show "CLR" and then return to measurement mode.

• If the value measured by the meter is not close to the selected buffer, "WRONG  " and "WRONG  " messages will blink alternately. In this case check if the correct buffer has been used, or regenerate the electrode by following the cleaning procedure (see page 18). If necessary, change the buffer or the electrode.

- The “**WRONG**” message and temperature value are displayed blinking if the temperature reading is out of the defined temperature range of the buffer. Calibration cannot be confirmed in this situation.
- Press **RANGE** to display the temperature reading on the LCD during calibration (**HI2211** only).



ONE-POINT CALIBRATION

- Proceed as described in “Two-point calibration” section.
- Press **CAL** after the first calibration point was confirmed.



The instrument will return to measurement mode and will memorize the one-point calibration data (new offset).

The instrument will use the slope from the previous calibration. The default slope will be used if there is no previous calibration.

TEMPERATURE CALIBRATION (for technical personnel only)

All the instruments are factory calibrated for temperature.

Hanna Instruments' temperature probes are interchangeable and no temperature calibration is needed when they are replaced.

If the temperature measurements are inaccurate, temperature recalibration should be performed. For an accurate recalibration, contact your local Hanna Instruments Office.

- Prepare a vessel containing ice and water and another one containing hot water (around 50 °C). Place insulation material around the vessels to minimize temperature changes.
- Use a calibrated thermometer with a resolution of 0.1 °C as a reference thermometer.
- With the instrument off, press and hold down the **CAL & MEM** keys, then power on the instrument. The "CAL" message will appear and the secondary LCD will show "0.0 °C".



- Submerge the temperature probe in the vessel with ice and water as near as possible to the reference thermometer. Allow a few seconds for the probe to stabilize.
- Use the **ARROW** keys to set the reading on the secondary LCD to that of ice and water, measured by the reference thermometer.

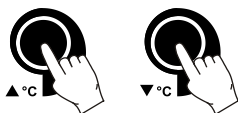

- When the reading is stable and close to the selected calibration point, "READY" message will appear and "CFM" message will blink.
- To confirm press **CFM**. The secondary LCD will show "50.0 °C".

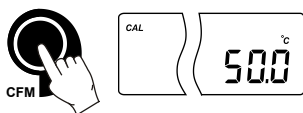

- Submerge the temperature probe in the second vessel as near as possible to the reference thermometer. Allow a few seconds for the probe to stabilize.
- Use the **ARROW** keys to set the reading on the secondary LCD to that of the hot water.

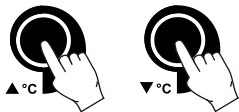

- When the reading is stable and close to the selected calibration point, “READY” tag will appear and “CFM” tag will blink.
- Press **CFM** to confirm. The instrument returns to measurement mode.



Note: If the reading is not close to the selected calibration point, “WRONG” tag will blink. Change the temperature probe and restart calibration.

pH BUFFER TEMPERATURE DEPENDENCE

The temperature has an effect on pH. The calibration buffer solutions are affected by temperature changes to a lesser degree than normal solutions. During calibration the instrument will automatically calibrate to the pH value corresponding to the measured or set temperature.

TEMP		pH VALUES				
°C	°F	4.01	6.86	7.01	9.18	10.01
0	32	4.01	6.98	7.13	9.46	10.32
5	41	4.00	6.95	7.10	9.39	10.24
10	50	4.00	6.92	7.07	9.33	10.18
15	59	4.00	6.90	7.05	9.27	10.12
20	68	4.00	6.88	7.03	9.22	10.06
25	77	4.01	6.86	7.01	9.18	10.01
30	86	4.02	6.85	7.00	9.14	9.96
35	95	4.03	6.84	6.99	9.11	9.92
40	104	4.04	6.84	6.98	9.07	9.88
45	113	4.05	6.83	6.98	9.04	9.85
50	122	4.06	6.83	6.98	9.01	9.82
55	131	4.08	6.84	6.98	8.99	9.79
60	140	4.09	6.84	6.98	8.97	9.77
65	149	4.11	6.84	6.99	8.95	9.76
70	158	4.12	6.85	6.99	8.93	9.75

During calibration the instrument will display the pH buffer value at 25 °C.

ELECTRODE CONDITIONING AND MAINTENANCE

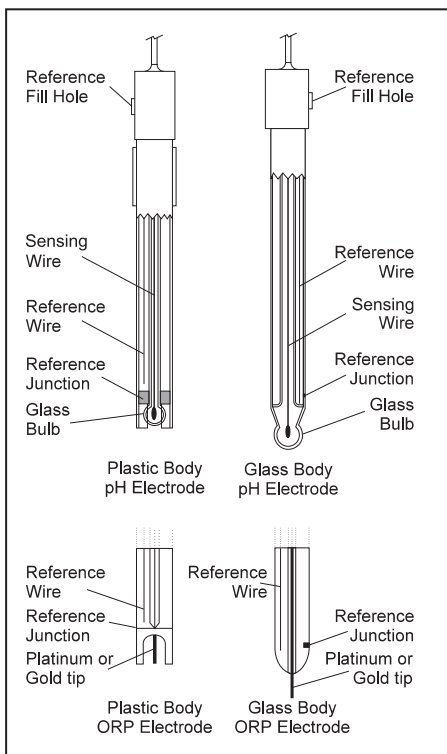

PREPARATION PROCEDURE

Remove the protective cap of the pH electrode.

DO NOT BE ALARMED IF SALT DEPOSITS ARE PRESENT. This is normal with electrodes. They will disappear when rinsed with water.

During transport, tiny bubbles of air may form inside the glass bulb affecting proper functioning of the electrode. These bubbles can be removed by "shaking down" the electrode as you would do with a glass thermometer.

If the bulb and/or junction is dry, soak the electrode in **H170300** or **H180300** Storage Solution for at least one hour.

For refillable electrodes:

If the filling solution (electrolyte) is more than 2½ cm (1") below the fill hole, add **HI7082** or **HI8082** 3.5M KCl Electrolyte Solution for double junction or **HI7071** or **HI8071** 3.5M KCl + AgCl Electrolyte Solution for single junction electrodes.

Unscrew the fill hole screw during measurements.

For AmpHel® electrodes:

If the electrode does not respond to pH changes, the battery is dead and the electrode should be replaced.

MEASUREMENT

Rinse the electrode tip with distilled water. Submerge the tip (3 cm /1¼") into the sample and stir gently for a few seconds.

For a faster response and to avoid cross-contamination of the samples, rinse the electrode tip with a few drops of the solution to be tested, before taking measurements.

STORAGE PROCEDURE

To minimize clogging and assure a quick response time, the glass bulb and the junction should be kept moist and not allowed to dry out.

Replace the solution in the protective cap with a few drops of **HI70300** or **HI80300** Storage Solution or, in its absence, Fill Solution (**HI7071** or **HI8071** for single junction and **HI7082** or **HI8082** for double junction electrodes). Follow the Preparation Procedure on page 16 before taking measurements.

Note: NEVER STORE THE ELECTRODE IN DISTILLED OR DEIONIZED WATER.

PERIODIC MAINTENANCE

Inspect the electrode and the cable. The cable must be intact and well connected. No cracks should be seen on the electrode stem or bulb. Connectors must be perfectly clean and dry. If any scratches or cracks are present, replace the electrode. Rinse off any salt deposits with water.

For refillable electrodes:

Refill the reference chamber with fresh electrolyte (**HI7071** or **HI8071** for single junction or **HI7082** or **HI8082** for double junction electrodes). Allow the electrode to stand upright for 1 hour.

Follow the Storage Procedure above.

CLEANING PROCEDURE

- General Soak in Hanna Instruments **HI7061** or **HI8061** General Cleaning Solution for approximately ½ hour.
- Protein Soak in Hanna Instruments **HI7073** or **HI8073** Protein Cleaning Solution for 15 minutes.
- Inorganic Soak in Hanna Instruments **HI7074** Inorganic Cleaning Solution for 15 minutes.
- Oil/grease Rinse with Hanna Instruments **HI7077** or **HI8077** Oil and Fat Cleaning Solution.

IMPORTANT: After performing any of the cleaning procedures, rinse the electrode thoroughly with distilled water, refill the reference chamber with fresh electrolyte (not necessary for gel-filled electrodes) and soak the electrode in **HI70300** or **HI80300** Storage Solution for at least 1 hour before taking measurements.

TROUBLESHOOTING GUIDE

SYMPTOMS	PROBLEM	SOLUTION
Slow response/ excessive drift.	Dirty pH electrode.	Clean the electrode and then soak the tip in HI7061 or HI8061 for 30 minutes.
Readings fluctuate up and down (noise).	Clogged/dirty junction. Low electrolyte level (refillable electrodes only).	Clean the electrode. Refill with fresh solution (for refillable electrodes only). Check cable and connector.
The meter does not accept the buffer solution for calibration.	Dirty electrode or contaminated buffer.	Follow the cleaning procedure. If still no results, replace the electrode. Replace Buffer.
If the display shows "pH" and "-2.00" or "16.00" blinking.	Out of range in the pH scale.	a) Verify that the electrode is connected. b) Verify that the shipping cap has been removed. c) Recalibrate the meter. d) Make sure the pH sample is in the specified range. e) Check the electrolyte level and the general state of the electrode.
The display shows "mV" and "-2000" or "2000" blinking.	Out of range in the mV scale.	Verify that the electrode is connected.
The meter does not work with the temperature probe.	Broken temperature probe. Wrong temperature probe used.	Replace the temperature probe.
The meter fails to calibrate or gives faulty readings.	Broken pH electrode.	Replace the electrode.
At startup the meter displays all LCD tags permanently.	One of the keys is stuck.	Check the keyboard or contact the vendor.
"Err xx" error message displayed.	Internal error.	Power off the meter and then power it on. If the error persists, contact the vendor.

TEMPERATURE CORRELATION FOR pH SENSITIVE GLASS

The resistance of glass electrodes partially depends on the temperature. The lower the temperature, the higher the resistance. It takes more time for the reading to stabilize if the resistance is higher. In addition, the response time will suffer to a greater degree at temperatures below 25 °C.

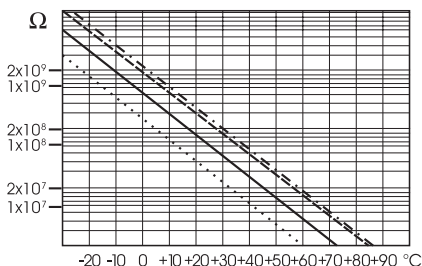

Since the resistance of the pH electrode is in the range of 50-200 Mohms, the current across the membrane is in the pico Ampere range. Large currents can disturb the calibration of the electrode for many hours.

For these reasons high humidity environments, short circuits and static discharges are detrimental to a stable pH reading.

The pH electrode's life also depends on the temperature. If constantly used at high temperatures, the electrode life is drastically reduced.

Typical Electrode Life

Ambient Temperature	1- 3 years
90 °C	Less than 4 months
120 °C	Less than 1 month

Alkaline Error

High concentrations of sodium ions interfere with readings in alkaline solutions. The pH at which the interference starts to be significant depends upon the composition of the glass. This interference is called alkaline error and causes the pH to be underestimated.

Hanna Instruments' glass formulations have the indicated characteristics.

Sodium Ion Correction for Glass at 20-25 °C		
Concentration	pH	Error
0.1 Mol L ⁻¹ Na ⁺	13.00	0.10
	13.50	0.14
	14.00	0.20
1.0 Mol L ⁻¹ Na ⁺	12.50	0.10
	13.00	0.18
	13.50	0.29
	14.00	0.40

ACCESSORIES

pH BUFFER SOLUTIONS

HI70004P	pH4.01 Buffer Sachets, 20 mL, 25 pcs.
HI70007P	pH7.01 Buffer Sachets, 20 mL, 25 pcs.
HI70010P	pH10.01 Buffer Sachets, 20 mL, 25 pcs.
HI7004L	pH4.01 Buffer Solution, 500 mL bottle
HI7006L	pH6.86 Buffer Solution, 500 mL bottle
HI7007L	pH7.01 Buffer Solution, 500 mL bottle
HI7009L	pH9.18 Buffer Solution, 500 mL bottle
HI7010L	pH10.01 Buffer Solution, 500 mL bottle
HI8004L	pH4.01 Buffer Sol. in FDA approved bottle, 500 mL
HI8006L	pH6.86 Buffer Sol. in FDA approved bottle, 500 mL
HI8007L	pH7.01 Buffer Sol. in FDA approved bottle, 500 mL
HI8009L	pH9.18 Buffer Sol. in FDA approved bottle, 500 mL
HI8010L	pH10.01 Buffer Sol. in FDA approved bottle, 500 mL

ELECTRODE STORAGE SOLUTIONS

HI70300L	Storage Solution, 500 mL bottle
HI80300L	Storage Solution in FDA approved bottle, 500 mL

ELECTRODE CLEANING SOLUTIONS

HI70000P	Electrode Rinse Sachets, 20 mL, 25 pcs.
HI7061L	General Cleaning Solution, 500 mL bottle
HI7073L	Protein Cleaning Solution, 500 mL bottle
HI7074L	Inorganic Cleaning Solution, 500 mL bottle
HI7077L	Oil & Fat Cleaning Solution, 500 mL bottle
HI8061L	General Cleaning Sol. in FDA approved bottle, 500 mL
HI8073L	Protein Cleaning Solution in FDA approved bottle, 500 mL
HI8077L	Oil&Fat Cleaning Sol. in FDA approved bottle, 500 mL

ELECTRODE REFILL ELECTROLYTE SOLUTIONS

HI7071	3.5M KCl + AgCl Electrolyte, 4x30 mL, for single junction electrodes
HI7072	1M KNO ₃ Electrolyte, 4x30 mL
HI7082	3.5M KCl Electrolyte, 4x30 mL, for double junction electrodes
HI8071	3.5M KCl + AgCl Electrolyte in FDA approved bottle, 4x30 mL, for single junction electrodes
HI8072	1M KNO ₃ Electrolyte in FDA approved bottle, 4x30 mL

ORP PRETREATMENT SOLUTIONS

HI7091L	Reducing Pretreatment Solution, 500 mL bottle
HI7092L	Oxidizing Pretreatment Solution, 500 mL bottle

pH ELECTRODES

All electrodes part numbers ending with B are supplied with BNC connector and 1 m (3.3') cable, as shown below:

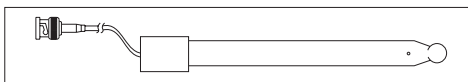

HI1043B

Glass-body, double junction, refillable, combination pH electrode.
Use: strong acid/alkali.

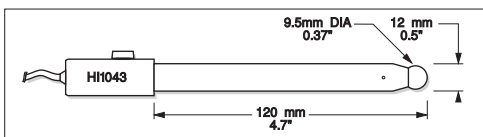

HI1053B

Glass-body, triple ceramic, conic shape, refillable, combination pH electrode. Use: emulsions.

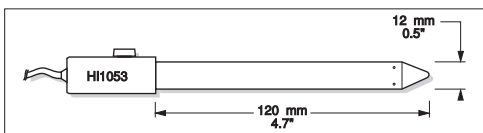

HI1083B

Glass-body, micro, Viscolene, non-refillable, combination pH electrode.
Use: biotechnology, micro titration.

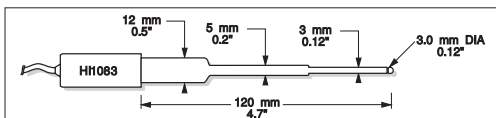

HI1131B

Glass-body, double junction, refillable, combination pH electrode.
Use: general purpose.

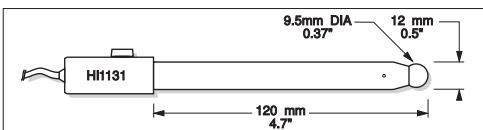

HI1330B

Glass-body, semimicro, single junction, refillable, combination pH electrode. Use: laboratory, vials.

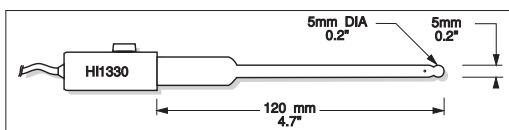

HI1331B

Glass-body, semimicro, single junction, refillable, combination pH electrode. Use: flasks.

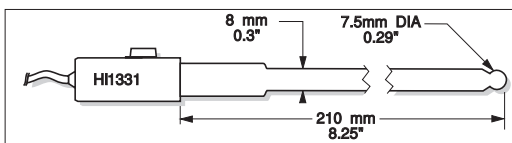

HI1230B

Plastic-body (PES), double junction, gel-filled, combination pH electrode. Use: general, field.

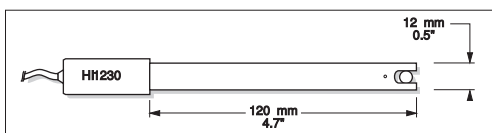

HI2031B

Glass-body, semimicro, conic, refillable, combination pH electrode. Use: semisolid products.

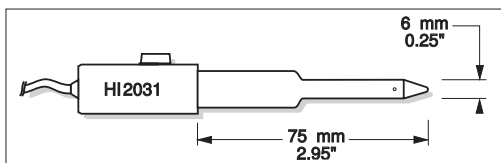

HI1332B

Plastic-body (PES), double junction, refillable, combination pH electrode. Use: general purpose.

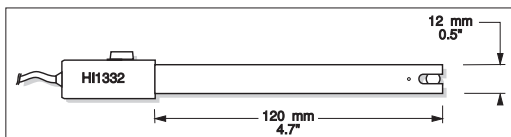

FC100B

Plastic-body (PVDF), double junction, refillable, combination pH electrode. Use: general purpose for food industry.

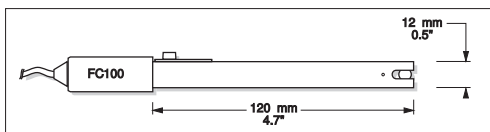

FC200B

Plastic-body (PVDF), open junction, conic, Viscolene, non-refillable, combination pH electrode. Use: meat & cheese.

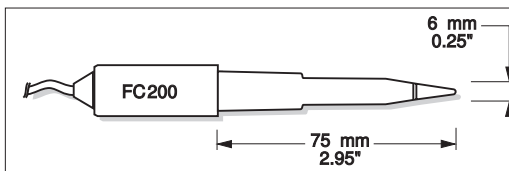

FC210B

Glass-body, double junction, conic, Viscolene, non-refillable, combination pH electrode. Use: milk, yogurt.

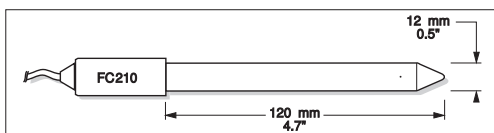

FC220B

Glass-body, triple-ceramic, single junction, refillable, combination pH electrode. Use: food processing.

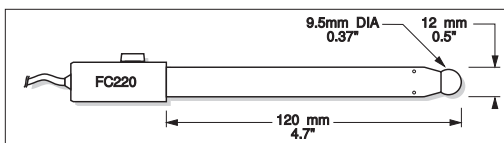

FC911B

Plastic-body (PVDF), double junction, refillable with built-in amplifier, combination pH electrode. Use: very high humidity.

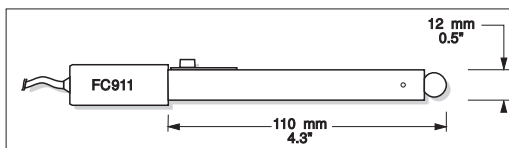

HI1413B

Glass-body, single junction, flat tip, Viscolene, non-refillable, combination pH electrode. Use: surface measurement.

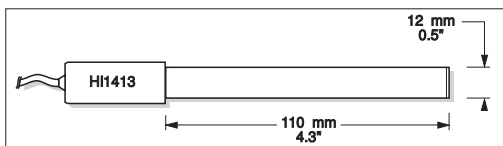

ORP ELECTRODES

HI3131B

Glass-body, refillable, combination platinum ORP electrode.

Use: titration.

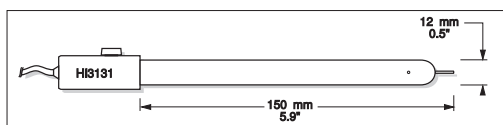

HI3230B

Plastic-body (PES), gel-filled, combination platinum ORP electrode.

Use: general purpose.

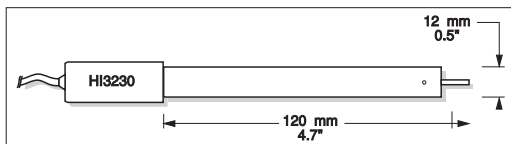

HI4430B

Plastic-body (PES), gel-filled, combination gold ORP electrode.

Use: general purpose.

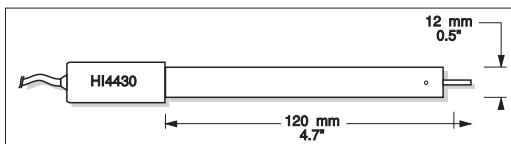

Consult the Hanna Instruments General Catalog for more electrodes with screw-type or BNC connectors.

EXTENSION CABLE FOR SCREW-TYPE ELECTRODES (SCREW TO BNC ADAPTER)

HI7855/1	Extension cable 1 m (3.3') long
HI7855/3	Extension cable 3 m (9.9') long

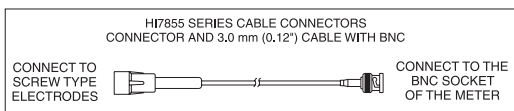

OTHER ACCESSORIES

HI710005	Voltage adapter from 115 VAC to 12 VDC (USA plug)
HI710006	Voltage adapter from 230 VAC to 12 VDC (European plug)
HI710012	Voltage adapter from 240 VAC to 12 VDC (UK plug)
HI710014	Voltage adapter from 230 VAC to 12 VDC (Australian plug)
HI76404N	Electrode holder

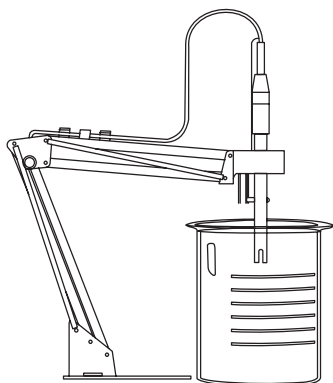

HI8427	pH and ORP electrode simulator with 1 m (3.3') coaxial cable ending in female BNC connectors
HI931001	pH and ORP electrode simulator with LCD and 1 m (3.3') coaxial cable ending in female BNC connectors
HI7662	Temperature probe with 1 m (3.3') cable

WARRANTY

HI2210 and **HI2211** are guaranteed for two years against defects in workmanship and materials when used for their intended purpose and maintained according to instructions. Electrodes and probes are guaranteed for six months. This warranty is limited to repair or replacement free of charge.

Damage due to accidents, misuse, tampering or lack of prescribed maintenance is not covered.

If service is required, please contact your local Hanna Instruments Office. If under warranty, report the model number, date of purchase, serial number and the nature of the problem. If the repair is not covered by the warranty, you will be notified of the charges incurred. If the instrument is to be returned to Hanna Instruments, first obtain a Returned Goods Authorization number from the Technical Service department and then send it with shipping costs prepaid. When shipping any instrument, make sure it is properly packed for complete protection.

RECOMMENDATIONS FOR USERS

Before using this product, make sure it is entirely suitable for your specific application and for the environment in which it is used.

Any variation introduced by the user to the supplied equipment may degrade the meters' performance. For yours and the meter's safety do not use or store the meter in hazardous environments.

Hanna Instruments reserves the right to modify the design, construction or appearance of its products without advance notice.



World Headquarters

Hanna Instruments Inc.
Highland Industrial Park
584 Park East Drive
Woonsocket, RI 02895 USA
www.hannainst.com

Local Office

Hanna Instruments Inc.
Highland Industrial Park
584 Park East Drive
Woonsocket, RI 02895 USA
Phone: 800.426.6287
Fax: 401.765.7575
e-mail: tech@hannainst.com